

Advanced Features 2 x 30A or 1 x 60A Brushless DC Motor Controller with USB and CAN



RoboteQ's SBLM2360 is a features-packed, high-current, dual or single channel controller for brushless DC motors. The controller can operate in one of several modes in order to sense the rotor position and sequence power on the motor's 3 windings in order to generate smooth continuous rotation. The controller also uses the Hall sensor and/or Encoder information to compute speed and measure travelled distance inside a 32-bit counter. The motors may be operated in open or closed loop speed mode, position mode or in torque mode.

The SBLM2360 features several Analog, Pulse and Digital I/Os which can be remapped as command or feedback inputs, limit switches, or many other functions. The SBLM2360 accepts commands received from an RC radio, Analog Joystick, wireless modem, or microcomputer. For mobile robot applications, the controller's two motor channels can either be operated independently or mixed to move and steer a vehicle. Using CAN bus, up to 127 controllers can be networked at up to 1Mbit/s on a single twisted pair.

Numerous safety features are incorporated into the controller to ensure reliable and safe operation. The controller's operation can be extensively automated and customized using Basic Language scripts. The controller can be configured, monitored and tuned in real-time using a RoboteQ's free PC utility. The controller can also be reprogrammed in the field with the latest features by downloading new operating software from Roboteq.

Applications

- Automatic Guided Vehicles
- Small Electric Vehicles, Electric Bikes
- Terrestrial and Underwater Robotic Vehicles
- Police and Military Robots
- Hazardous Material Handling Robots
- Balancing Robots
- Telepresence Systems
- Animatronics

Key Features

- USB, Serial, 0-5V Analog, or Pulse (RC radio) command modes
- One RS232 serial port
- CAN bus interface up to 1Mbit/switch multiple protocol support
- Auto switch between Serial, USB, CAN, Analog, or Pulse based on user-defined priority
- Built-in dual 3-phase high-power drivers for two brushless DC motor at up to 30A
- Output channels can be paralleled in order to drive a single motor at up to 60A
- Multiple Motor Operating mode
 - Trapezoidal with Hall Sensors
 - Sinusoidal with Encoders
 - Sinusoidal with Hall Sensors
- Support for absolute angle encoders
 - sin/cos analog
 - SSI differential or single ended
- Field Oriented Control in Sinusoidal modes
- Full forward & reverse motor control. Four quadrant operation. Supports regeneration
- Operates from a single 10V-60V power source
- STO - Safe Torque Off support (T-version)
- Design compliant/approval UL 61800-5-1
- Programmable current limit up to 30A (60A on single channel version) per motor for protecting controller, motor, wiring and battery.
- Separate connector for Hall Sensors
- Accurate speed and Odometry measurement using Hall Sensor or Encoder data
- Up to 8 Analog Inputs for use as command and/or feedback
- Up to 8 Pulse Length, Duty Cycle or Frequency Inputs for use as command and/or feedback

- Up to 10 Digital Inputs for use as Deadman Switch, Limit Switch, Emergency stop or user inputs
- Inputs for up to 2 Quadrature Encoders
- 4 general purpose 24V, 1.5A output for brake release or accessories
- Selectable min, max, center and dead band in Pulse and Analog modes
- Selectable exponentiation factors for each command inputs
- Trigger action if Analog, Pulse or Hall counter capture are outside user selectable range (soft limit switches)
- Open loop or closed loop speed control operation
- Closed loop position control with encoder, hall sensors, analog or pulse/frequency feedback
- Torque mode
- PID control loop
- Built-in Battery Voltage and Temperature sensors
- Optional backup power input for powering safely the controller if the main motor batteries are discharged
- Power Control wire for turning On or Off the controller from external microcomputer or switch
- No consumption by output stage when motors stopped
- Regulated 5V output for powering RC radio, RF Modem, sensors or microcomputer
- Separate Programmable acceleration and deceleration for each motor
- Ultra-efficient 3.3 mOhm ON resistance MOSFETs (1.65 mOhm on Single Channel)
- Stall detection and selectable triggered action if Amps is outside user-selected range
- Short circuit protection
- Overvoltage and Undervoltage protection
- Watchdog for automatic motor shutdown in case of command loss
- Overtemperature protection
- Diagnostic LED
- ABS plastic enclosure with heat conducting bottom plate
- Efficient heat sinking. Operates without a fan in most applications.
- Dustproof and weather resistant. IP30 rating
- Power wiring using high-current-handling Molex MegaFit type connectors terminals
- 4.8" (123.0mm) L, 3.3" W (83.0mm), 1.0" (25mm) H
- -40° to +85° C operating environment
- Weight: 0.47 lbs (215g)
- Easy configuration, tuning and monitoring using provided PC utility
- Field upgradeable software for installing latest features via the internet Orderable Product References

Specifications and Listings

Controller is designed and built to comply with UL and IEC specifications and standards, but is approved only under the mentioned standards on this datasheet.

Orderable Product References

Reference	Number of Channels	Amps/Channel	Volts
SBLM2360T	2	30	60
SBLM2360TS	1	60	60

Important Safety Disclaimer

Dangerous uncontrolled motor runaway condition can occur for a number of reasons, including, but not limited to: command or feedback wiring failure, configuration error, faulty firmware, errors in user script or user program, or controller hardware failure.

The user must assume that such failures can occur and must make his/her system safe in all conditions. Roboteq will not be liable in case of damage or injury as a result of product misuse or failure.

Power Terminals Identifications and Connection

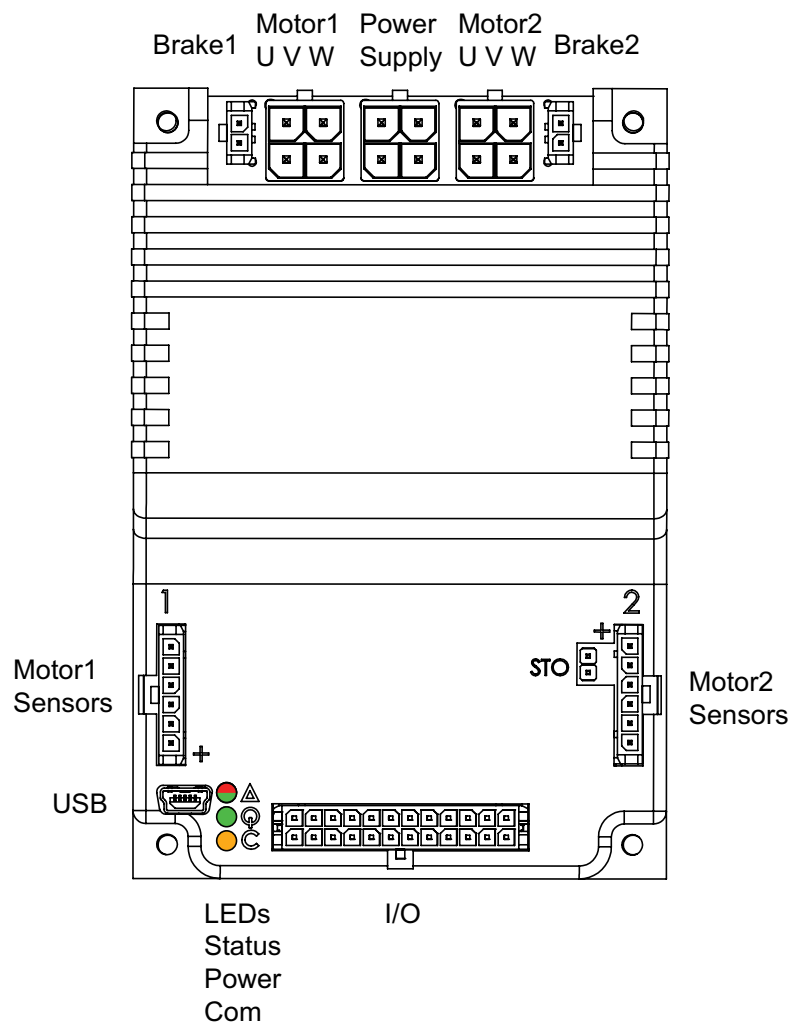

FIGURE 1. SBLM23xx Outline

Figure 2, below, shows how to wire the controller in a dual motor configuration, and how to turn power On and Off.

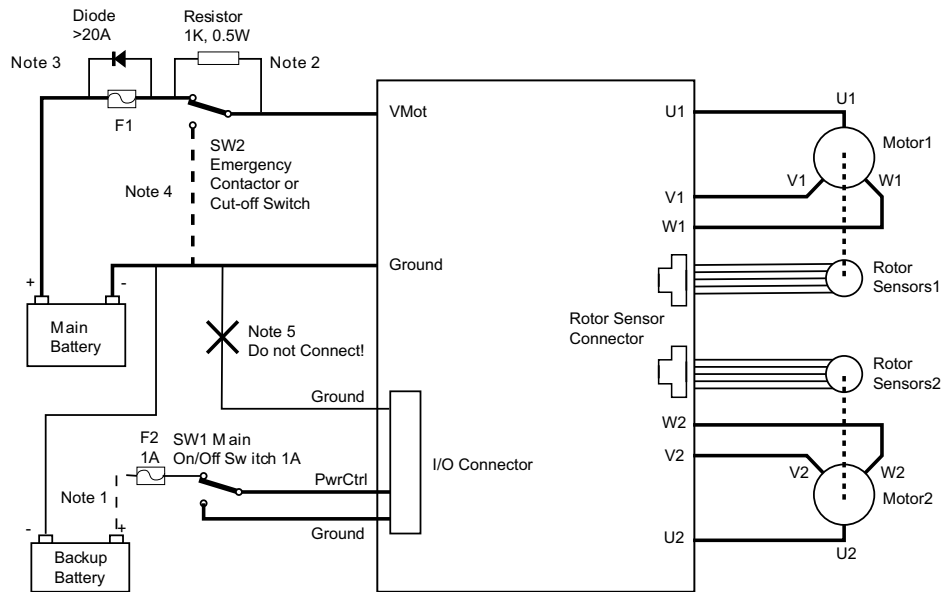

FIGURE 2. Powering the Controller. Thick lines identify MANDATORY connections

Important Warning

Carefully follow the wiring instructions provided in the Power Connection section of the User Manual. The information on this datasheet is only a summary.

Mandatory Connections

It is imperative that the controller is connected as shown in the above diagram in order to ensure a safe and trouble-free operation. All connections shown as thick black lines are mandatory. The controller must be powered On/Off using switch SW1 on the PwrCtrl terminal. Use a suitable high-current fuse F1 (check table 10) as a safety measure to prevent damage to the wiring in case of major controller malfunction.

Emergency Switch or Contactor

The battery must be connected in permanence to the controller's VMot terminal via a high-power emergency switch or contactor SW2 as additional safety measure. The user must be able to deactivate the switch or contactor at any time, independently of the controller state.

Electrostatic Discharge Protection

In accordance with IEC 61000-6-4, Roboteq Motor Controllers are designed to withstand ESD up to 4kV touch and 8kV air gap. This protection is implemented without any additional external connections required.

Some specifications, such as EN12895, require a higher level of protection. To maximize ESD protection, up to 8kV touch and 15kV air gap, you may connect the metallic heatsink of the controller to your battery negative terminal. [See App Note 062918 for example connections.](#)

Precautions and Optional Connections

- Note 1: Backup battery to ensure motor operation with weak or discharged batteries, connect a second battery to the Power Control wire/terminal via the SW1 switch.
- Note 2: Use precharge 1K, 0.5W Resistor to prevent switch arcing.
- Note 3: Insert a high-current diode to ensure a return path to the battery during regeneration in case the fuse is blown.
- Note 4: Optionally ground the Vmot terminal when the controller is Off if there is any concern that the motors could be made to spin and generate voltage in excess of 60V.
- Note 5: Connect the controller’s bottom plate to a wire connected to the Earth while the charger is plugged in the AC main, or if the controller is powered by an AC power supply.
- Note 6: Beware not to create a path from the ground pins on the I/O connector and the battery minus terminal.

Single Channel Wiring

On the Single Channel SBLM2360S, the each of the motor wire must be connected to both output terminal of the same letter as shown in the figure below. Use the Encoders and/or Hall sensors of Channel 1 for operation.

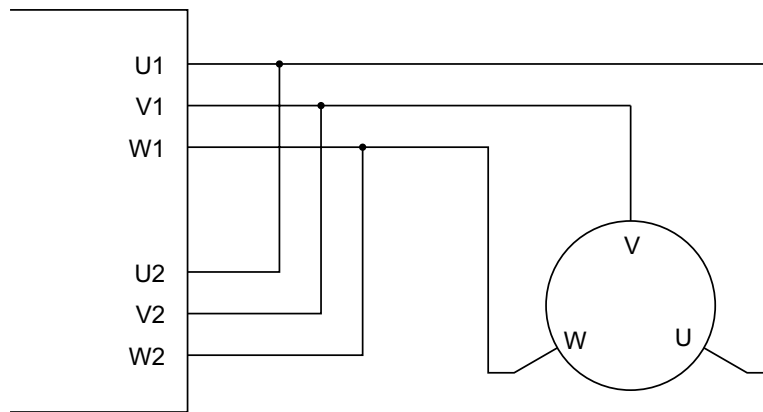

FIGURE 3. Single Channel Wiring Diagram

Important Warning

This wiring must be done only on the single channel version of the controller. Paralleling the wires on a dual channel product will cause permanent damage. Verify that your controller is an SBLM2360S before you wire in this manner.

Use of Safety Contactor for Critical Applications

An external safety contactor must be used in any application where damage to property or injury to person can occur because of uncontrolled motor operation resulting from failure in the controller’s power output stage.

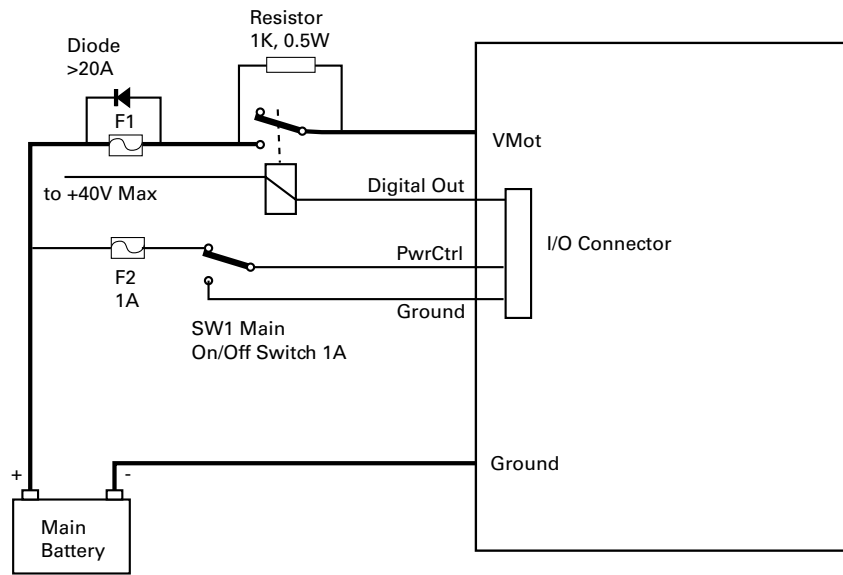

FIGURE 4. Contactor Wiring Diagram

The contactor coil must be connected to a digital output configured to activate when “No MOSFET Failure”. The controller will automatically deactivate the coil if the output is expected to be off and battery current of 1A or more is measured for more than 0.5s. This circuit will not protect against other sources of failure such as those described in the “Important Safety Disclaimer” on page 3.

Power and Motor Connections

Connection to the battery is made using two a 4-pin Molex MegaFit connectors. Use mating connector model 170001-0104. Both GND and VMOT pins are doubled in order to carry higher current.

Another 4-pin Molex MegaFit connector is provided for each motor. 3 pins supply the U, V and W phase voltages. A Ground pin can be used for an optional motor cable shield.

A 2-pin Molex MicroFit connector is provided for connecting a brake for each motor (see next section). Use mating connector model 43645-0200

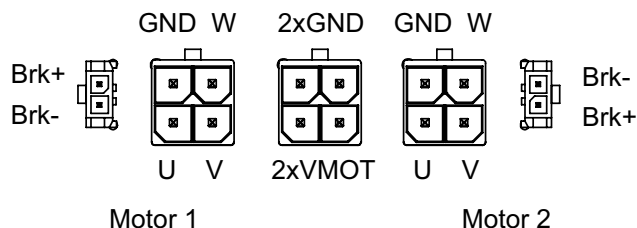

FIGURE 5. SBLM23xx Power and Motor Connectors

Motor Brake Connection

Two pins on the motor connector are provided for connection to a motor brake. The output is modulated with a PWM signal so that a higher voltage can be initially applied to energize the coil, and then reduced to maintain the brake released while consuming less energy.

Important Warning

The Brk+ is internally connected to the VMOT supply voltage. Exercise care to avoid short circuits during wiring.

Note that brake outputs activations 1 and 2 are shared with digital outputs 3 and 4 on the 24-pin I/O connector.

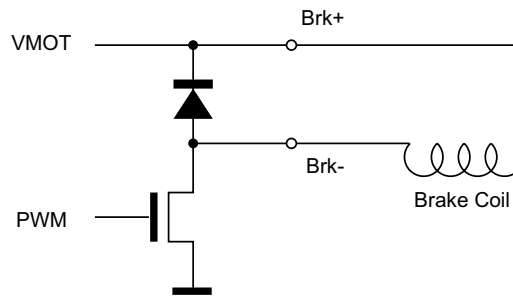

FIGURE 6. Brake drive circuit and connection

Controller Mounting

During motor operation, the controller will generate heat that must be evacuated. The published amps rating can only be fully achieved if adequate cooling is provided. Good conduction cooling can be achieved by having the bottom surface of the case making direct contact with a metallic surface (chassis, cabinet). The mounting has to be like that, so that the thermal-safety limits are not exceeded.

Hall Sensors Connection

Connection to the Hall Sensors is done using a special connector on the front side of the controller. The Hall sensor connector is a 6-pin Molex Microfit 3.0, ref. 43645-0600. Pin assignment is in the table below.

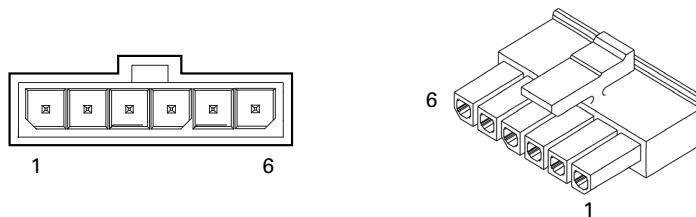

FIGURE 7. Hall Sensors Connector

TABLE 1.

Pin Number	1	2	3	4	5	6
Signal	5V		Hall C	Hall B	Hall A	Ground

Hall Sensor vs Motor Output sequencing

The controller requires the Hall sensors inside the motor to be 120 degrees apart. The controller's 3-phase bridge will activate each of the motor winding according to the sequence shown in the figure below..

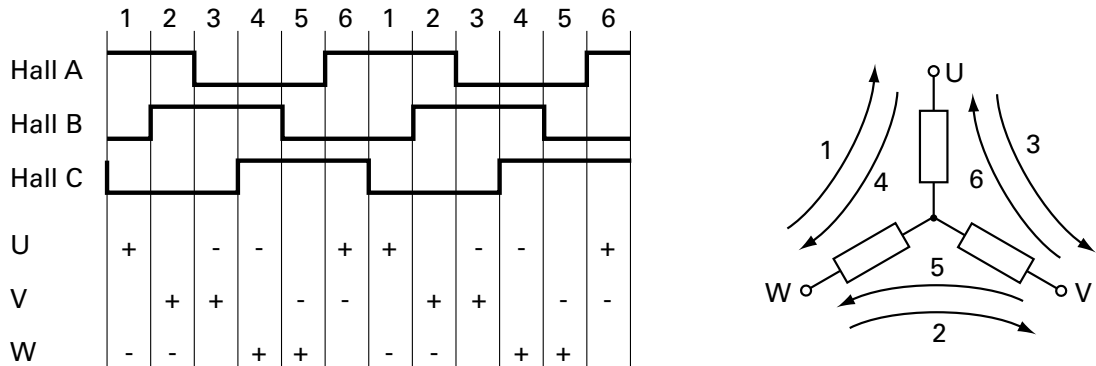

FIGURE 8. Hall Sensors Sequence

Connection to SSI Absolute Encoder

In Sinusoidal Mode, the controller can use motors equipped with absolute angle sensors with SSI interface. When enabled, the SSI signals are found on the 6-pin Molex connectors that is otherwise used for the Hall Sensors. The controller issues a differential clock signal and expects a up to 16-bit differential data signal from the encoder. When two motors are used, these signals must be connected to both sensors. Serial data from each sensor is captured on separate input pins.

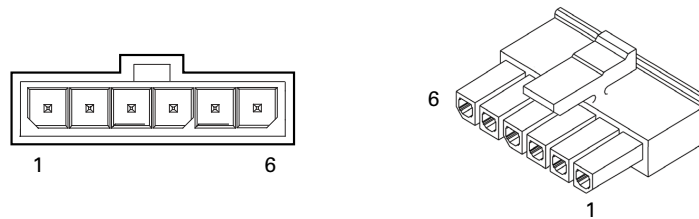

FIGURE 9. Motor sensor connector used for SSI Encoders

TABLE 2.

Pin Number	1	2	3	4	5	6
Signal	5V	Clock -	Clock +	Data -	Data +	Ground

Connection to Analog Sin/Cos Absolute Encoder

The SBLM2360 has 4 high-speed analog inputs that can be used to capture absolute angle position from resolvers or magnetic sensors with sin/cos voltage outputs. The signal must be 0-5V max with the 0 at 2.500V. The sensor can be single ended or differential.

TABLE 3. Differential Sin/Cos signals on the SBLM23xxx

Pin Number	1	2	3	4	5	6
Signal	5V	Cos-	Cos+	Sin-	Sin+	Ground

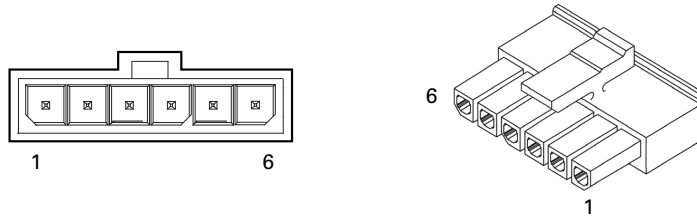

FIGURE 10. Motor sensor connector pin identification

Commands and I/O Connections

Connection to RC Radios, Microcomputers, Joysticks and other low current sensors and actuators are done via the 24-pin Molex Microfit connector. Use mating connectors models 44914-24010 or 44914-24000. The functions of many pins vary depending on controller model and user configuration. Pin assignment is found in the table below.

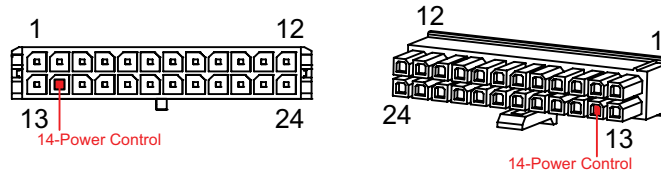

FIGURE 11. Main Connector Pin Locations

TABLE 4.

Connector Pin	Power	Dout	Com	Pulse	Ana	Dinput	Enc	STO	Hall (1)
1	GND								
13	5VOut								
2				PIN8	ANA8	DIN8	ENC1B		
14	Power Ctrl								
3									
15				PIN7	ANA7	DIN7	ENC1A		
4									

Connector Pin	Power	Dout	Com	Pulse	Ana	Dinput	Enc	STO	Hall (1)
16				PIN6	ANA6	DIN6	ENC2B		Hall2C
5			CANL						
17				PIN5	ANA5	DIN5	ENC2A		Hall2B
6		DOUT4							
18			CANH						
7		DOUT2							
19		DOUT3							
8	GND								
20		DOUT1							
9				PIN3	ANA3	DIN3		STO1	Hall1C
21				PIN4	ANA4	DIN4		STO2	Hall2A
10			RS RxD						
22				PIN2	ANA2	DIN2			Hall1B
11			RS TxD						
23				PIN1	ANA1	DIN1			Hall1A
12	GND								
24	5VOut								

Note1: Hall inputs are activated in DB25 connector in firmware v2.0 or later and only if Molex input is configured as SSI Input. In that case user has to install 1K pull up resistor between each hall signal and 5VOut.

Default I/O Configuration

While the controller can be configured so that practically any Digital, Analog and RC pin can be used for any purpose, the controller's factory default configuration provides an assignment that is suitable for most applications. You may omit any connection that is not required in your application. The controller automatically arbitrates the command priorities depending on the presence of a valid command signal in the following order: 1-RS232, 2-RC Pulse, 3-None. If needed, use the Roborun+ PC Utility to change the pin assignments and the command priority order.

Enabling Analog Commands

For safety reasons, the Analog command mode is disabled by default. To enable the Analog mode, use the PC utility and set Analog in Command Priority 2 or 3 (leave Serial as priority 1). Note that by default the additional securities are enabled and will prevent the motor from starting unless the potentiometer is centered, or if the voltage is below 0.25V or above 4.75V. The drawing shows suggested assignment of Pot 1 to ANA1 and Pot 2 to ANA4. Use the PC utility to enable and assign analog inputs.

USB communication

Use USB only for configuration, monitoring and troubleshooting. USB is not a reliable communication method when used in an electrically noisy environments and communication will not always recover after it is lost without unplugging and replugging the connector, or restarting the controller. Always prefer RS232 communication when interfacing to a computer. USB and CAN can operate at the same time on the SBLM2360. Plugging USB to a computer will not disable CAN interface.

Status LEDs and Flashing Patterns

The controller is equipped with 3 LEDs. A Green Power LED, a Red/Green Status LED, and a Yellow Communication LED. After the controller is powered on, the Power LED will turn on, indicating that the controller is On. The Status LED will be flashing at a two second interval. The flashing pattern and colour provides operating or exception status information.

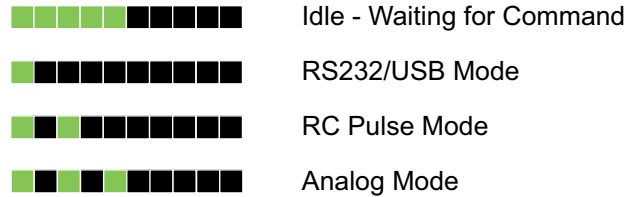

FIGURE 12. Normal Operation Flashing Patterns

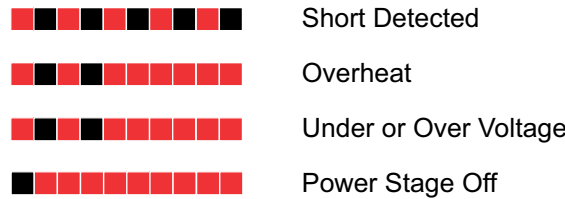

FIGURE 13. Exception or Fault Flashing Patterns

Additional status information may be obtained by monitoring the controller with the PC utility.

The communication LED gives status information on the CAN and USB.

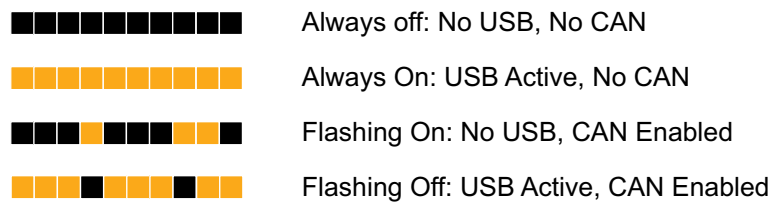

FIGURE 14. Communication LED Flashing Patterns

Measured Amps

The controller includes Amps sensors in line with the motor terminals and on the battery ground terminals. Both Motor Amps and Battery Amps are therefore measured with precision.

When motor is rotating, amps are AC. The SBLM2360 measures and is rated based on RMS Amps. The table below shows the relation between the RMS current and the DC Equivalent in Sinusoidal and

Trapezoidal modes. In sinusoidal mode, DC equivalent are the amps resultant from the torque (Iq) and quadrature (Id) vectors. In trapezoidal mode, they are the DC amps that flow through the two coils that are active at any one time.

	Amps RMS	DC Equivalent
Sinusoidal	120A	170A (Irms * 1.414)
	60A	85A (Irms * 1.414)
Trapezoidal	120A	147A (Irms * 1.225)
	60A	73.5 (Irms * 1.225)

Safe Torque Off - STO

Safe Torque Off is a safe method for switching controller in a state where no torque is generated, regardless whether the controller is operating normally or is faulty. When STO is enabled, two digital inputs, DIN3 and DIN4 are remapped as STO1 and STO2. The inputs are redundant and both must have a 6V to 30V signal present at the same time in order for the Power MOSFETs to be energized. The controller will perform a self-check of the STO circuit at every power on and every time the STO inputs go from any state to both high. Once the STO hardware is verified to work, the controller will safely allow the motors to be energized. If either input is below 1V, the controller's outputs will be disabled. The STO circuit is verified and validated and can therefore be trusted instead of external relays. See [STO Manual](#) for more information and maintenance instructions.

By factory default STO functionality is disabled. It must be enabled by removing the jumper located on the controller's PCB. STO functionality is only available in the T version of the controller.

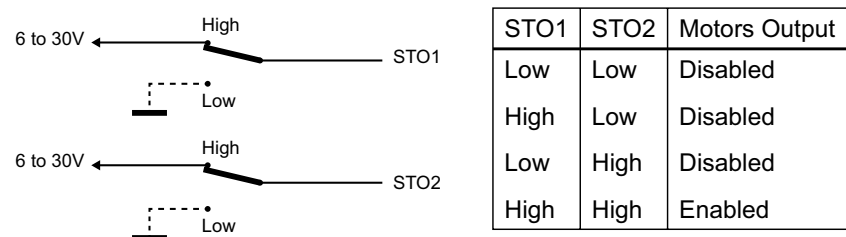

FIGURE 15. STO input levels effects on controller output

The STO function is compliant to:

- IEC 61800-5-2:2007, SIL 3
- IEC 61508:2010, SIL 3
- IEC 62061:2005, SIL 3
- ISO 13849-1:2015, Category 3 Performance Level e

Important Warning

Activating STO does lead to no more torque generation on the motor. The motor will not be actively stopped but run out. In case of a multiple fault in the power stage a rotation might occur.

Electrical Specifications

Absolute Maximum Values

The values in the table below should never be exceeded, permanent damage to the controller may result.

TABLE 5.

Parameter	Measure point	Min	Typ	Max	Units
Battery Leads Voltage	Ground to VBat			60 (2)	Volts
Reverse Voltage on Battery Leads	Ground to VBat	-1			Volts
Power Control Voltage	Ground to Pwr Control wire			60 (2)	Volts
Motor Leads Voltage	Ground to U, V, W wires			60 (2)	Volts
Digital Output Voltage	Ground to Output pins			30	Volts
Analog and Digital Inputs Voltage	Ground to any signal pin on 15-pin & Hall inputs			30	Volts
RS232 I/O pins Voltage	External voltage applied to Rx pin			30 (3)	Volts
Case Temperature	Case	-40		85	°C
Humidity	Case			100 (4)	%

Note 1: Only PELV/SELV voltages shall be used

Note 2: Can be even higher because of regeneration voltage. Never inject a DC voltage from a battery or other fixed source

Note 3: No voltage must be applied on Tx pin

Note 4: Non condensing

Power Stage Electrical Specifications (at 25°C ambient)

TABLE 6.

Parameter	Measure point	Model	Min	Typ	Max	Units
Battery Leads Voltage	Ground to VMot	All	0 (1)		60	Volts
Input Continuous current	Power source current	All			40	Amps
Output Voltage	Ground to U, V, W wires	All	0 (1)		60 (2)	Volts
Power Control Voltage	Ground to Power Control wire	All	0 (1)		65	Volts
Minimum Operating Voltage	VBat or Pwr Ctrl wires	All	10 (3)			Volts
Over Voltage protection range	Ground to VMot	All	5	60 (4)	63	Volts
Under Voltage protection range	Ground to VMot	All	0	5 (4)	63	Volts
Idle Current Consumption	VMot or Pwr Ctrl wires	All	50	100 (5)	150	mA
ON Resistance (Excluding wire resistance)	VMot to U, V or W. Ground to U, V or W	SBLM23xx		3.3		mOhm
		SBLM23xxS		1.65		mOhm
Max Current for 30s	Motor current	SBLM23xx			30	Amps
		SBLM23xxS			60	Amps
Continuous Max Current per channel	Motor current	SBLM23xx			20 (6)	Amps
		SBLM23xxS			40 (6)	Amps
Current Limit range	Motor current	SBLM23xx	10	30 (7)	30	Amps
		SBLM23xxS	20	60 (7)	60	Amps

TABLE 6.

Parameter	Measure point	Model	Min	Typ	Max	Units
Stall Detection Amps range	Motor current	SBLM23xx	10	30 (7)	30	Amps
		SBLM23xxS	20	60 (7)	60	Amps
Stall Detection timeout range	Motor current	All	1	500 (8)	65000	msec
Short Circuit Detection threshold (9)	Between Motor wires or Between Motor wires and ground or Between Motor wires and Vmot	SBLM23xx			85 (10)	Amps
		SBLM23xxS			190 (10)	Amps
Motor Acceleration/Deceleration range	Motor Output	All	100	500 (11)	65000	msec
Power cable thickness	Power input and output	All		12		AWG

Note 1: Negative voltage will cause a large surge current. Protection fuse needed if battery polarity inversion is possible

Note 2: Can be even higher because of regeneration voltage. Never inject a DC voltage from a battery or other fixed source

Note 3: Minimum voltage must be present on VBat or Power Control wire

Note 4: Factory default value. Adjustable in 0.1V increments

Note 5: Current consumption is lower when higher voltage is applied to the controller's VBat or PwrCtrl wires

Note 6: Estimate. Limited by case temperature. Current may be higher with better cooling

Note 7: Factory default value. Adjustable in 0.1A increments

Note 8: Factory default value. Time in ms that Stall current must be exceeded for detection

Note 9: Controller will stop until zero command given in case of short circuit detection

Note 10: Approximate value

Note 11: Factory default value. Time in ms for power to go from 0 to 100%

Command, I/O and Sensor Signals Specifications

TABLE 7.

Parameter	Measure point	Min	Typ	Max	Units
Main 5V Output Voltage	Ground to 5V pins on	4.6	4.75	4.9	Volts
5V Output Current	5V pins on Molex and DSub25			150 (1)	mA
Digital Output Voltage	Ground to Output pins			30 (2)	Volts
Output On resistance	Output pin to ground		0.25	0.5	Ohm
Output Short circuit threshold	Output pin	1.7		3.5	Amps
Digital Output Current	Output pins, sink current			1.5(2)	Amps
Input Impedances (except DIN7-8)	AIN/DIN Input to Ground		53		kOhm
Digital Input 0 Level	Ground to Input pins	-1		1	Volts
Digital Input 1 Level	Ground to Input pins	3		30	Volts
Analog Input Range	Ground to Input pins	0		5.1	Volts
Analog Input Precision	Ground to Input pins		0.5		%
Analog Input Resolution	Ground to Input pins		1		mV
Pulse durations	Pulse inputs	20000		10	us
Pulse repeat rate	Pulse inputs	50		250	Hz

TABLE 7.

Parameter	Measure point	Min	Typ	Max	Units
Pulse Capture Resolution	Pulse inputs		1		us
Frequency Capture	Pulse inputs	100		2000	Hz

Note 1: Sum of all 5VOut outputs
 Note 2: Outputs are Open Drain. They pull to ground when on and float when off. Load must be connected between output and positive voltage

Operating & Timing Specifications

TABLE 8.

Parameter	Measure Point	Min	Typ	Max	Units
Command Latency	Command to output change	0	0.5	1	ms
PWM Frequency	Motor Output	10	16	25	kHz
Closed Loop update rate	Internal		1000		Hz
RS232 baud rate	Rx & Tx pins		115200 (1)		Bits/s
RS232 Watchdog timeout	Rx pin	1 (2)		65000	ms

Note 1: 115200, 8-bit, no parity, 1 stop bit, no flow control
 Note 2: May be disabled with value 0

Scripting

TABLE 9.

Parameter	Measure Point	Min	Typ	Max	Units
Scripting Flash Memory	Internal		32000		Bytes
Max Basic Language programs	Internal	1000		3000	Lines
Integer Variables	Internal		4096		Words (1)
Boolean Variables	Internal		8192		Symbols
Execution Speed	Internal	50 000	100 000		Lines/s

Note 1: 32-bit words

Thermal Specifications

TABLE 10.

Parameter	Measure Point	Min	Typ	Max	Units
Case Temperature	Case	-40		85 (1)	°C
Thermal Protection range	Case	80		90 (2)	°C
Power Dissipation	Case			10	Watts
Thermal resistance	Power MOSFETs to plate			0.6	°C/W
Humidity	Case			95	%
Ambient temperature	Ambient			55	°C
Pollution Degree	-	PD 2			

TABLE 10.

Parameter	Measure Point	Min	Typ	Max	Units
Fast fuse to install(3)(4)	SBLM23xx	20	2 x 20		Amps
	SBLM23xxS		2 x 20		Amps
Overload protection	-	Check Note 5			
<p>Note 1: Thermal protection will protect the controller power</p> <p>Note 2: Max allowed power out starts lowering at minimum of range, down to 0 at max of range</p> <p>Note 3: There are two power terminals. Fuse should be installed in both of them for safety.</p> <p>Note 4: In dual channel controller, for operating only one channel install 20A fuse and for operating both channels 2 x 20A fuse should be installed. Power source must be capable to blow the fuse instantly in case of short circuit</p> <p>Note 5: Current limiting mechanism available through firmware. External overload motor protection can be used if required (provided by user)</p>					

STO Specifications

TABLE 11.

Parameter	Measure Point	Min	Typ	Max	Units
STO Input High Level	Ground to STO input pin	6		30	Volts
STO Input Low Level	Ground to STO input pin	0		1	Volts
STO Response Time	Input to output change			5	msec
STO Operating temperature		-20		55	°C
STO Storage temperature		-20		70	°C
Humidity		5		95	%
IP degree				IP30	
Operating Altitude				2000	m
Cable Length				2	m
EMC Immunity	According to IEC 61800-3 and IEC 61800-5-2 Annex E				
CE Declaration	Available at www.roboteq.com				

Mechanical Specifications

TABLE 12.

Parameter	Measure Point	Min	Typ	Max	Units
Weight	Board		215 (0.47)		g (lbs)
Power Connectors Wiring	Terminals	12		22	AWG

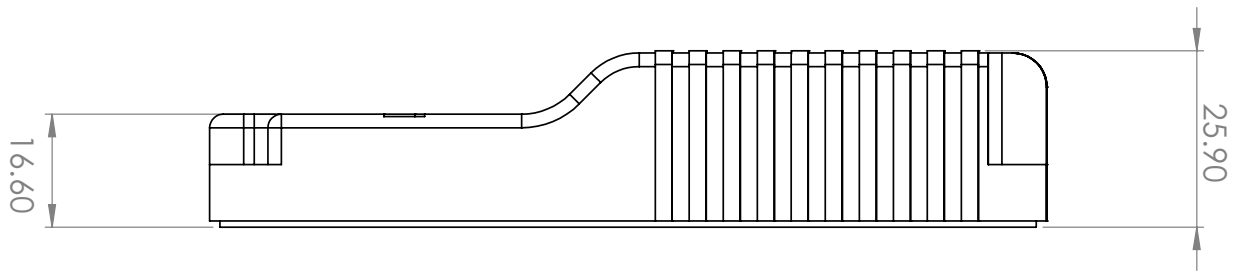

FIGURE 16. SBLM23xx Side View and Dimensions

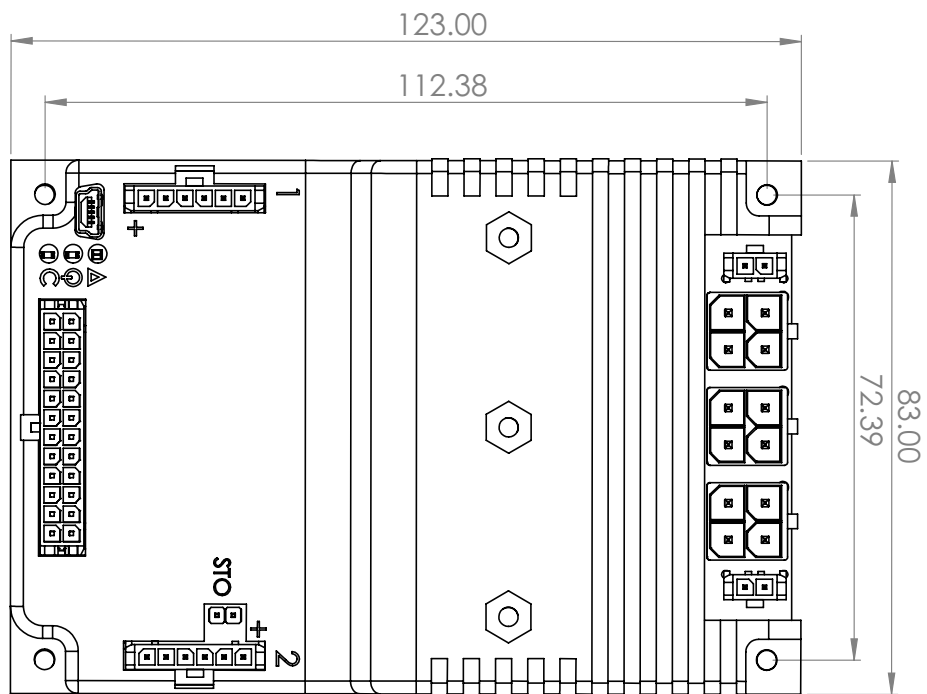

FIGURE 17. SBLM23xx Top View and Dimensions